



## E00/E01 Series Modular Piezo Controller

### User Manual

Version: V1.0



This document describes the following products:

- E00/E01 Chassis with Power Supply
- E03/E05/E06/E07/E08 Amplifier Modules
- E09 PZT Sensor/Piezo Servo Control Modules
- E18 Display / Interface Modules

# DECLARATION

## Declaration!

This user manual is a integrated user manual of the E00/E01 series piezoelectric controller. Customers can use the different modules to assemble and use. Please read this user manual carefully before using this controller. Follow the instructions in the manual during use. If there is any problem, please contact us for technical support. If you do not follow this manual or disassemble and modify the product yourself, the company will not be liable for any consequences arising therefrom.

Please read the following to avoid personal injury and to prevent damage to this product or any other product connected to it. In order to avoid possible hazards, this product can only be used within the specified range.

## Notice!

Use only the dedicated power cord supplied with this product. Check the power cord before use and confirm that it is in good condition.

This product should be connected to the ground through the power cord. Use a power outlet with a safe and reliable grounding wire.

Do not touch any exposed ends of the product and its accessories.

There is high voltage inside, and the chassis must not be opened privately.

Do not pull or plug in the input and output lines and serial ports, I/O, and USB cables while the power is on.

The control method used should be correspond to the selected control method.

Please keep the surface of the product clean and dry, and do not operate in a humid or Large electrostatic environment.

After use, the output voltage should be cleared to zero and the servo state is switched to the open loop state before the controller switch is turned off .

## Danger!

The piezoelectric power amplifier described in this manual is a high-voltage device capable of outputting high currents, which can cause serious or even fatal damage if not used properly.

It is strongly recommended that you do not touch any parts that connect to the high voltage output.

Special Note: If you connect it with other products in addition to our company, please follow the general accident prevention procedures.

Operating the high-voltage amplification requires training professional operators.

## Warning!

If the voltage exceeds the PZT's tolerable range, it will cause permanent damage to the PZT. Before adding voltage to the PZT poles, it must be ensured that the positive and negative poles of the PZT are connected correctly and the operating voltage is within the allowable range of this PZT.

## Cautious!

The E00/E01 housing should be installed on a horizontal surface in an area with a 3CM air flow area to prevent internal convection in the vertical direction.

Insufficient airflow can cause equipment to overheat or premature instrument damage.

## Note!

When there is no corresponding module in the E00/E01 system, please do not control the module for the system. When there is no module, there is no control signal to provide a loop for the power amplifier module, which will cause the system to malfunction.

The module position corresponding to the E00/E01 system can only be placed in the corresponding module. If you wanna upgrade your E00/E01 system, please contact the sales engineer or contact our customer service department, and the contact information in chapter 9.

# Contents

1. Safety .....	2
1.1 Design Use .....	2
1.2 Safety Instructions .....	2
1.3 User Manual Notes .....	2
2. Introduction .....	3
2.1 Overview .....	3
2.2 Configuration Example .....	5
2.3 Compatibility Note .....	6
2.4 System Block Diagram .....	7
2.5 Maximum Rating .....	7
2.6 Environmental Conditions .....	8
3. Operation .....	8
3.1 Unpacking Inspection .....	8
3.2 System Operation and Safety Measures .....	9
3.3 Electrical Inspection .....	10
3.4 Connecting Cables .....	10
3.5 Getting Started .....	11
4. Module Description .....	12
4.1 Chassis and Power Supply .....	12
4.2 E00/E01 System Chassis Size .....	13
4.3 E03 HVPZT Power Amplifier Module .....	14
5. Power Calculation .....	15
6. Maintenance, Storage, Transportation .....	15
6.1 Cleaning Measures .....	15
6.2 Replacement Fuse .....	15
6.3 Transportation and Storage .....	16
7. Service and Repair .....	16
7.1 Disposal of Used Equipment .....	16
7.2 After-Sales and Maintenance .....	17
8. Customer Service .....	17
9. Contact us .....	17
Annex 1. E00/E01 Component Module .....	18
Annex 2. E00/E01 Series Introduction .....	19
Annex 3. E00/E01 Series Picture .....	20
Annex 4. Module Description .....	22
Annex 5. System accessories .....	44

## 1. Safety

### 1.1 Design Use

- ▶ E00/E01 system is designed for integrated user use and laboratory equipment.
- ▶ Keep the surface of E00/E01 system clean and dry. Do not operate in a humid or Large electrostatic environment.
- ▶ E00/E01 system is used to drive capacitive loads (eg: piezo actuator).
- ▶ E00/E01 system must not be used in other user manuals with the same name. It is important to note that this E00/E01 system cannot be used to drive resistive or inductive loads.
- ▶ E00/E01 system is available for both static and dynamic operating applications.
- ▶ The available servo modes for the E00/E01 system include SGS, LVDT, and CAP sensors.

### 1.2 Safety Instructions

E00/E01 system is based on nationally recognized safety standards and improper use may result in personal injury or damage to E00/E01 system. The operator is responsible for the proper installation and operation of E00/E01 system. E00/E01 system is equipped with function modules. If the modules are removed from the chassis, it may cause personal injury or damage to the E00/E01 system.

- ▶ Read the user manual in detail.
- ▶ Please immediately remove any malfunctions and safety hazards caused by malfunctions.
- ▶ Only authorized and qualified professional technicians can remove the module from the chassis.
- ▶ When removing the module from the chassis, the power to E00/E01 system should be unplugged from the power outlet.

### 1.3 User Manual Notes

When using E00/E01 system, the user manual and E00/E01 system are integrated and should be placed near the system for easy access.

If the user manual is missing or damaged, please contact our customer service department.

Please include all information given in the manufacturer's user manual, such as supplements or technical notes, etc.

If your user manual is incomplete, you will miss a lot of important information, causing serious or

fatal injuries and property damage. E00/E01 system can be installed and operated by reading and understanding the contents of the user manual.

E00/E01 system can only be installed, operated, maintained and cleaned by qualified personnel who are authorized to meet the technical requirements.

## 2. Introduction

### 2.1 Overview



E00/E01 Control System

E00/E01 series piezoceramic controller is a high quality drive power source designed for piezoelectric ceramic actuators. It provides piezoelectric ceramics with high stability, high resolution voltage, excellent frequency response and extremely low static ripple. E00/01 Series Products with multiple control modes, multiple models, and multiple configurations can meet the needs of different users.

E00/E01 system consists of four modules with different functions: power amplifier module (AMPLIFIER), PZT sensor control module (PZT-SERVO), display and interface module (DISPLY/INTERFACE), chassis and multiple power modules (Chassis and Power Supply). The modules with different functions are connected to all the connectors between the modules through the common signal connection board in the chassis. The multiple modules with different functions and performance parameters can be combined to form hundreds of different functions and performance parameters. Realize the serialization and layering of products, greatly satisfy the different needs of different customers, and achieve maximum flexibility. This is one of the most notable features of our company's E00/E01 modular control system products superior to the

domestic and foreign companies in the same industry. (Please refer to Annexure-1).

E00 series control system integrates a multi-supply power supply 19-inch chassis and power amplifier module to form a basic configuration of PZT (piezoelectric ceramic) control system, which can be configured with E09 series position control sensor module and E18 series display and computer interface module. An E00 control system can combine up to 18 independent control channels.

E01 series control system integrates multi-supply power supply 9.5-inch chassis and power amplifier module to form the basic configuration of PZT (piezoelectric ceramic) control system, configurable E09 series piezoelectric servo control module and E18 series display / interface module, an E01 control system can combine up to 9 independent control channels.

Model	Mandatory Configuration	Expandable Module	Max Channel Qty.
E00	19" power amplifier module (E03/E05/E06/E07E08)	Sensor control module (E09) Display and interface module (E18)	18
E01	9.5" power amplifier module (E03/E05/E06/E07E08)	Sensor control module (E09) Display and interface module (E18)	9

Note: For details about the models and functions , please refer to Appendix 1.

### **Standard modular design provides great flexibility**

Thanks to its modular construction, E00/E01 series of piezo controllers can be used in many different applications. Many types of sensor modules can be mounted in a 19" / 9.5" chassis.

The amplifier module includes an average output power of 7W to 35W. Depending on the frequency bandwidth and configuration range, a wide range of power amplifiers up to 35W can be installed, including single and triple channels.

### **Position sensor**

Position servo control requires positioning feedback signals, and the SGS resistance strain gauge / LVDT inductive / CAP capacitive sensor provides this feedback signal. Regardless of the sensor, there are dedicated excitation and feedback signals, and any combination of sensors can be used in the same body.

### **Manually operate analog signals**

The DC offset knob potentiometer DC-OFFSET or the external analog control signal CONTROL INPUT on the panel can be used as the excitation signal of PZT.

### **USB and RS-232/422 communication**

Control the entire PZT system via USB or RS-232/422 using a common command language.

### **Position accuracy**

Accurate, smooth, linear and repeatable movements are possible, and high-resolution position sensors detect changes in PZT.

The piezoelectric servo control module has an independent PID control algorithm inside.

### **Advanced servo control**

Servo position control is consistent with the high-performance PZT position, which can be used in conjunction with SGS resistance strain gauge/LVDT inductive/CAP capacitive sensors, fully synchronized with the sensor, reduces cycle times and provides high resolution .

### **Fast response**

Dynamic Use Operation PZT movement requires high charging and discharging currents, and the power amplification module can solve these problems through different power supply channels. All power amplifier modules provide short-term peak current that gives PZT movements with extremely short rise and settling times.

## **2.2 Configuration Example**



E01 system with standard configuration

The system configuration is as follows:

- E01 chassis and power supply
- Amplifier slot: E03.00 three-channel power amplifier module
- Sensing servo slot: E09.S3 three-channel PZT sensor control module
- Display / interface slot: E18.i3 three-channel display / interface module



E00 system with standard configuration

The system configuration is as follows:

- E00 chassis and power supply
- Amplifier slot: E03.00 three-channel power amplifier module \*2
- Sensing servo slot: E09.S3 three-channel PZT sensor control module \*2
- Display / interface slot: E18.i3 three-channel display / interface module \*2

## 2.3 Compatibility Note

Since 2011, Harbin Core Tomorrow Science & Technology Co., Ltd. has made corresponding improvements and upgrades to the common signal connection backplane (E00/E01) in the system chassis, and the modules in the E00/E01 system have been adjusted accordingly.

- ▶ There is no compatibility between the power amplifier module, the sensor control module, the display and the interface module, and there are fixed plug-in positions. It is forbidden to insert other position and cause unnecessary loss.
- ▶ Older modular components combined with newer modular components in the E00/E01 system can cause system failures and damage to the system.
- ▶ If you need to replace a new E00/E01 system chassis or module assembly, please contact our customer service department.



## 2.4 System Block Diagram

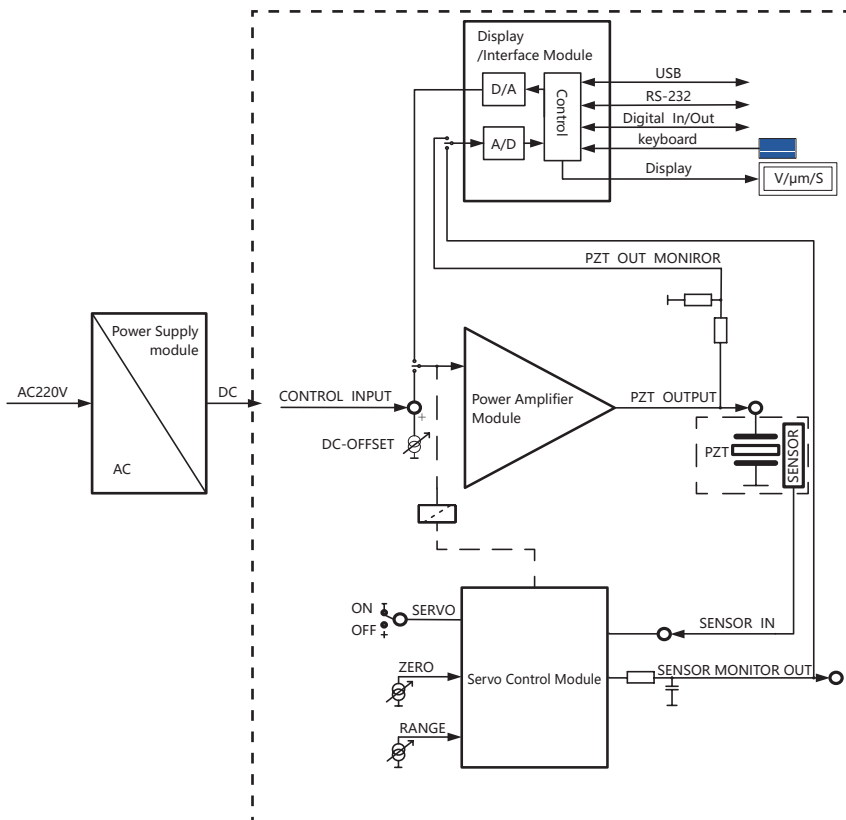

## 2.5 Maximum Rating

Basic nominal data for the operation of the E00/E01 system:

Models	Max operating voltage range	Operating frequency	Max output power range
E00 system	200 ~ 240VAC (fuse:2A-250V)	50-60Hz	136VA
E01 system	200 ~ 240VAC (fuse:2A-250V)	50-60Hz	66VA

## 2.6 Environmental Conditions

The environment in which the E00/E01 system operates must comply:

Environmental conditions	Conditional description
Application area	Only for indoor use
Environment humidity	Maximum relative humidity 80%, temperature up to 30 °C Minimum relative humidity 50%, temperature up to 40 °C
Operating temperature	0°C ~ +50°C
Storage temperature	-10°C ~ +85°C

## 3. Operation

### 3.1 Unpacking Inspection

The E00/E01 system has been carefully checked for electrical and mechanical aspects prior to shipment. When you receive the device, unpack and check the surface of the system for any obvious signs of damage. If it is damaged, it may be damaged during transportation. Please contact our customer service department in time. Please keep the original packaging materials in a safe place for subsequent maintenance.

#### 3.1.1 The E00/E01 system must include the following items:

- Modules installed in the chassis
- Power cord
- Analog control line
- PZT output line (depending on the presence or absence of piezo actuators, nanopositioning stage, micro-motion stage)
- E00/E01 Series Piezo Controller User Manual (this document)

#### 3.1.2 If one or more E09 modules are installed, the following items are included:

- Sensor monitoring cable for E09.Sx/Lx models

### 3.1.3 If one or more E18 modules are installed, the following items are included:

- E18 Software Operation User Manual
- E18 software installation CD
- Serial cable
- USB cable
- I/O slot MDR connector cable

## 3.2 System Operation and Safety Measures

**NOTE!** Improper installation of E00/E01 system can result in personal injury or damage to the E00/E01 system!

- Installation and use of E00/E01 system should be close to the power supply, so that the power plug can be disconnected from the main power supply quickly and easily.
- Connect E00/E01 system using the supplied power cord.
- If the power cord supplied by the company must be replaced, use a power cord of sufficient size and be effectively grounded.

**NOTE!** E00/E01 system is installed or placed incorrectly, which may cause high temperature or overheating during system operation!

- E00/E01 system should be installed in an area with an air flow area of at least 3cm from the horizontal plane.
- Prevent vertical convection in the vertical direction. Insufficient airflow will cause overheating or premature instrument damage.
- Ensure a fully ventilated installation environment.

**NOTE!** When the piezo driver is connected to E00/E01 system, it may cause oscillation and cause irreparable damage!

If you find oscillation, please proceed as follows:

- When using the servo operation mode, please turn off the servo mode immediately.
- When using open loop operation, stop driving the piezoelectric actuator immediately.
- Turn off the E00/E01 system power.

**NOTE!** E00/E01 system is directly powered, and there will be thermal instability!

- Before using E00/E01, please turn on E00/E01 system for at least half an hour or more, then perform the corresponding operation.

**NOTE!** When using E00/E01 system, stop driving the piezoceramics before disposing of the

system!

- Turn off the servo mode (open loop operation).
  - The piezoceramic voltage is set to 0 V.
- 1) Analog mode: The input voltage target value is 0 V.
  - 2) Digital mode: The keyboard input is 0 V.
  - 3) Communication mode: Stop the communication command.

**NOTE!** Should pay attention to frosting when powering E00/E01 system up in winter, so as not to burn out the controller!

- Visually check the controller for frost before powering up (frosting occurs when moving from outside to indoors)
- If the controller is frosted, it should be wiped or dried and stored indoors for more than two hours before powering on.

## 3.3 Electrical Inspection

**NOTE!** If it is an instrument taken from the outside of the temperature below zero, it should be placed indoors for more than two hours and then energized!

- 1) Rotate the DC-OFFSET knobs of all the power amplifier modules in the system to the zero position (the unipolar controller rotates counterclockwise, and the bipolar is the middle position, that is, 5 turns).
- 2) Switch the SERVO sensor switch of all E09 modules in the system to OFF (open loop mode).
- 3) Connect the power cord.
- 4) Turn on the power switch (the switch is on the right side of the back of the system).
- 5) The green light of the power amplifier module lights up.
- 6) Adjust the DC bias potentiometer, if the E18 display / interface module is installed and observe the voltage display. The voltage display reading is the current PZT output voltage, and the value of the displacement or angle is not meaningful because the piezoelectric actuator and sensor are not connected.

If the system does not exhibit an abnormality when performing the above steps, the device has passed the electrical check.

## 3.4 Connecting Cables

**NOTE!** E09 piezo servo control module of each channel is calibrated at the factory with the

corresponding piezo actuator, eliminating the need for the user to recalibrate. The piezo actuators must be connected to the corresponding controller channel, and the number is indicated on the rear panel label of the device to see if it corresponds to the number of the piezo actuator!

After the system has passed the electrical inspection, the piezoelectric actuator can be connected to the system for corresponding operation. Please follow the steps below:

Turn off the system device.

Connect the piezoelectric actuator.

Each closed-loop piezoelectric actuator is equipped with two cables, a piezoelectric drive voltage cable and a piezoelectric sensor cable, and each open-loop piezoelectric actuator is only equipped with a piezoelectric drive voltage cable. Connect the piezo drive voltage cable to the PZT OUTPUT output socket of the system's power amplifier module and the piezo sensor cable to the system's piezo servo sensor SENSOR input socket.

## 3.5 Getting Started

### 3.5.1 Simulation operation

prompt! The analog signal or other control signal given by the external analog input signal or computer via DA can be used to generate the corresponding nominal analog signal!

chassis, and the modules in the E00/E01 system have been adjusted accordingly.

- ▶ Zero offset all DC-OFFSET bias potentiometers in the system.
- ▶ Switch all servos to OFF (open loop operation).

(Note: In the servo mode, the servo control circuit compares the control signal with the sensor feedback signal as the final target signal. The effects of nonlinearity and drift are eliminated in the servo mode. The display module will display the position reading information in real time. In the open loop mode, the servo control circuit is turned off. The device is a high voltage amplifier, the input signal is amplified to the corresponding voltage to the piezoelectric ceramic after the corresponding amplification factor. The output signal can be controlled by manual and DC offset OFFSET potentiometer. In open loop mode, the display module will display the voltage reading information in real time. The information of the position reading is not meaningful at this time.)

- ▶ Turn on the power.

(Note: If the E18 display/interface module is installed, the standard mode will appear on the display. The current output voltage and position sensor displacement will be displayed at the corresponding position on the screen. Because the controller is operating in open loop mode, The

reading of position sensor will be a certain value.)

- ▶ Servo switch is switched to ON (servo)

(Note: The piezoelectric actuator is controlled in the servo mode, and the screen displays the current displacement value.)

- ▶ Use the DC bias potentiometer DC-OFFSET to change the displacement.

- ▶ Control the nominal range with the external analog signal CONTROL INPUT.

(Note: The expansion and contraction of the piezoelectric actuator can be controlled by DC-OFFSET. The DC bias potentiometer can be superimposed on the external analog input, which is set to operate as a voltage offset to the control input, the unipolar signal is changed to a bipolar signal for control voltage.)

Overcurrent indicator LED lights up

(Note: If lit, the amplifier module output is off and the actuator is no longer consistent with the control signal.)

### 3.5.2 Computer control operation

- ▶ If the E18 display/interface module is installed, it can be controlled via RS-232 and USB interfaces.

- ▶ For details, please refer to E18 Hardware User Manual and E18 PC Software User Manual.

## 4. Module Description

### **important hint !**

The technical data of the products mentioned below are all nominal parameters. Special parameter data will not be specified in this user manual.

### 4.1 Chassis and Power Supply

#### 4.1.1 E00 System Chassis Technical Specifications

Models	E00.00
Function	Piezoelectric controller system for 19-inch chassis: Including power amplifier module, PZT sensor control module, display / interface module

Channel	Standard 1, 2, 3 (up to 6 independent E05/E03 power modules)
Operating voltage	200-240VAC, 50-60Hz
Max power	136VA

#### 4.1.2 E01 system chassis technical specifications

Model	E01.00
Features	Piezo Controller System for 9.5-Inch Chassis: Including power amplifier module, PZT sensor control module, display / interface module
Channel	Standard 1,3 (up to 3 independent E05/E03 power amplifier modules)
Operating voltage	200-240VAC, 50-60Hz
Maximum power	66VA

#### 4.2 E00/E01 System Chassis Size

System Models	Length (L)	Width (W)	Height (H)
E00.00	500mm	360mm(+Hind foot)	170mm(+Hind foot)
E01.00	280mm	360mm(+Hind foot)	170mm(+Hind foot)

##### 4.2.1 E00.00 Chassis module dimensional drawing

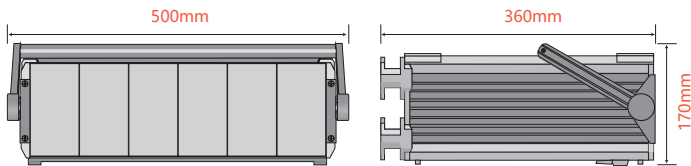

##### 4.2.2 E01.00 Chassis module dimensional drawing

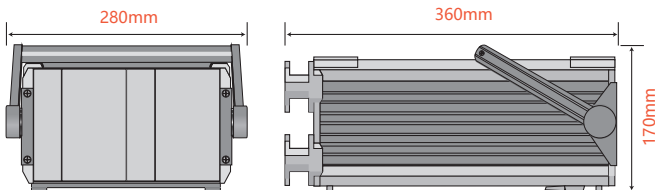

## 4.3 E03 HVPZT Power Amplifier Module

Danger! The E03 power amplifier module can output high voltages, and touching this high voltage can cause serious or even fatal injuries. Only qualified professional technicians can install, operate, maintain and clean the E03 Power Amplifier Module!

Model	Configuration parameter
E03.00	HVPZT, 7W, 1kHz, 3channel
E03.00S	HVPZT, 7W, 1kHz, 3channel, Constant-voltage
E03.05	HVPZT, 7W, 50kHz, 3channel
E05.00	HVPZT, 35W, 10kHz, 1channel (With 10A output peak current specification models)
E05.00S	HVPZT, 35W, 1channel, Constant-voltage
E05.03	HVPZT, 25W, 30kHz, 1channel
E05.05	HVPZT, 25W, 50kHz, 1channel
E06.00	HVPZT, 3W, 1kHz, 2/4channel
E07.00	HVPZT, 5W, 3kHz, 1channel
E05.20	E Combined module, Dual voltage output HVPZT, 70W, 1kHz, 1channel (2 modules)
E07.20	E Combined module, Dual voltage output HVPZT, 10W, 1kHz, 1channel (2 modules)
E08.20	E Combined module, Dual voltage output HVPZT, 34W, 3kHz, 1channel (2 modules)



## 5. Power Calculation

- Average output (Sine wave operation mode)

$$P_a \approx U_{pp} \cdot U_s \cdot f \cdot C_{piezo}$$

$P_a$  = Average output [W]

$C_{piezo}$  = Piezo actuator capacitance [F]

$U_{pp}$  = Peak and peak drive voltage [V]

$f$  = Operating frequency of the sine wave [Hz]

$U_s$  = Drive voltage [V] (  $(V_{s+}) - (V_{s-})$  )

## 6. Maintenance, Storage, Transportation

### 6.1 Cleaning Measures

Note! The PCB board of the function module in E00/E01 system is an ESD (electrostatic discharge) sensitive device. Take precautions against any static build-up of these devices before use to avoid contact with circuit component leads and PCB wiring. Before touching any electronic components, the body first touches the grounding conductor to discharge static electricity, ensuring that any type of conductive particles (metal, dust or debris, pencil lead, screws) enter the device. Be careful not to drop the equipment when cleaning, to avoid any form of mechanical shock!

Disconnect the power plug of E00/E01 system before cleaning.

Prevent cleaning fluid and any liquid from entering the system module to avoid short circuits.

The surface of the system chassis and the front panel of the module can be wiped with a solution with an alcohol content greater than 95%. Do not use an organic solvent for surface wiping.

### 6.2 Replacement Fuse

**Note!** E00/E01 system relies on 200 to 240V AC to work, and touching the line voltage can cause fatal injuries!

If the fuse fails and the entire system is not working, unplug the power cord from the E00/E01 system and replace it with a new one.

The fuse is model AC250V-3A and the power supply connection and fuse are located on the right side of the rear panel of the E00/E01 chassis.

If the system is still not working properly after replacing the new fuse, please contact your sales engineer or our after-sales service department immediately. The steps to remove the fuse are as follows:

- 1) Turn off the E00/E01 system and unplug the power cord.
- 2) After waiting for one minute, make sure any residual voltage has dissipated.
- 3) Open the holder that covers the fuse and pull out the fuse holder.
- 4) Replace the fuse of the same type and place it on the fuse holder.
- 5) Put the fuse holder back in place.

### 6.3 Transportation and storage

This product is packed in carton. Transportation must be carried out under product packaging conditions, and direct rain and snow, direct contact with corrosive gases and strong vibrations should be avoided during transportation.

The instrument can be transported under various conditions of normal transportation, and should avoid damp, load, collision, extrusion, irregular placement and other adverse conditions during transportation.

If the instrument is not used for a long time, the instrument should be packaged and stored.

The instrument should be stored in a non-corrosive atmosphere and in a well ventilated, clean room.

In the process of transportation, storage and use, attention should be paid to fire prevention, shockproof, waterproof and moisture proof.

## 7. Service and Repair

### 7.1 Disposal of Used Equipment

Please follow the national regulations and local regulations when handling old equipment. Please handle the old equipment correctly and environmentally. In order to meet the customer's handling of system products, the company provides upgrades and replacements for old equipment, please contact your sales engineer or contact customer service department.

If you have an old device or a device that you can no longer use, you can ship it to the following address:

- Building I2, No.191 Xuefu Road, Nangang District, Harbin, HLJ, China

## 7.2 After-Sales and Maintenance

The E00/E01 system does not contain user-serviceable parts.

Any service and repairs performed by the E00/E01 system must be returned to the factory.

Any attempt to remove any part of the E00/E01 system will void the warranty.

The E00/E01 system is a precision instrument and should be handled with care.

In case of problems, please record the fault condition and contact the dealer or manufacturer for repair by professional technicians.

## 8. Customer Service

If you have questions about the products you are currently using, please let us know the following information:

Product model number and related number

Controller model for this product

Software driver version for this product

Computer operating system

## 9. Contact us

**Harbin Core Tomorrow Science & Technology Co., Ltd.**

Tel: +86-451-86268790

Email: [info@coremorrow.com](mailto:info@coremorrow.com)

Website: [www.coremorrow.com](http://www.coremorrow.com)

Address: Building I2, No.191 Xuefu Road, Nangang District, Harbin, HLJ, China

**CoreMorrow Official and CTO WeChat are below:**



## Annex 1.E00/E01 Component Module

### ▷ **Housing and bracket system**

E00/E01 system has multi-function power supply module and a common signal connection backplane through which the power amplifier module, PZT sensor control module and display and interface modules are connected. E00/E01 racks are combined in sequence and all modules can be inspected for installation.

E00.00 Basic module carrier, 19-inch chassis with multiple power supply modules.

E01.00 Basic module carrier, 9.5-inch chassis with multiple power supply modules.

### ▷ **Amplifier module**

E03.00 power amplifier module, HVPZT, 7W, 1KHz, three channels

E03.00S power amplifier module, HVPZT, 7W, 1KHz, three channels and one of them is a constant voltage output

E03.05 Power amplifier module, HVPZT, 7W, 50KHz, three channels

E05.00 Power Amplifier Module, HVPZT, 35W, 10KHz, single channel, with 10A output peak current specification model

E05.00S power amplifier module, HVPZT, 35W, single channel, constant voltage output

E05.03 Power Amplifier Module, HVPZT, 25W, 30KHz, Single Channel

E05.05 Power Amplifier Module, HVPZT, 25W, 50KHz, Single Channel

E06.00 Power Amplifier Module, HVPZT, 3W, 1KHz, Two Channels / Four Channels

E07.00 power amplifier module, HVPZT, 5W, 3KHz, single channel

E05.20 E Combined two-electrode power amplifier module, HVPZT, 70W, 1KHz, single channel (2 modules)

E07.20 E Combined two-electrode power amplifier module, HVPZT, 10W, 1KHz, single channel (2 modules)

E08.20 E Combined two-electrode power amplifier module, HVPZT, 34W, 3KHz, single channel (2 modules)

### ▷ **Sensor control module**

E09.S1 PZT sensor control module, SGS sensor, single channel

E09.L1 PZT sensor control module, LVDT sensor, single channel

E09.C1 PZT sensor control module, CAP sensor, single channel

E09.S2 PZT sensor control module, SGS sensor, three channels

E09.L2 PZT sensor control module, LVDT sensor, three channels

E09.S3 PZT sensor control module, SGS sensor, three channels

E09.L3 PZT sensor control module, LVDT sensor, three channels

▷ **Display and interface module**

E18.i1 display / interface module, RS-232/422, USB, digital I/O, 16/24Bit D/A, single channel

E18.i3 Display / Interface Module, RS-232/422, USB, Digital I/O, 16/24Bit D/A, Triple Channels

## **Annex 2.E00/E01 Series Introduction**

E00/E01 system is combined into the following four series according to different functional modules.

▷ **A series products (open loop) - power amplification module**

PZT sensor control module slot and display/interface slots are unused and covered by the blank panel.

A series products consist only of power amplifier modules and chassis and multiple power modules. It only can open-loop drive for nanopositioning mechanisms such as PZT or micro-motion stages can be completed.

▷ **B Series (Open Loop & Servo) - Power Amplifier Module + PZT Sensor Control Module**

Display / interface slot, unused, covered by blank panel.

The B series products consist of a power amplifier module, a PZT sensor control module, and a chassis and multiple power modules. It can process the signals of various sensors and complete the servo control of nanopositioning mechanisms such as PZT or micro-motion stage to realize high-precision and high-resolution linear control.

▷ **C Series Products (Open Loop & Computer Interface) - Power Amplifier Module + Display / Interface Module**

Sensing servo slot, unused, covered by blank panel.

The C Series consists of a power amplifier module, display/interface module, and chassis and multiple power modules. Control commands from the computer can be received and processed through the computer interface, and human-computer interaction can also be performed through the keyboard, LCD and software.

## ▶ D Series (Open Loop & Servo & Computer Interface) - Power Amplifier Module + PZT Sensor Control Module + Display / Interface Module

D series products are composed of power amplifier module, PZT sensor control module, display / interface module and chassis and multi-channel power module, the most versatile and complete product. It can process the signals of various sensors to complete the servo control of the nano positioning mechanism such as PZT or micro-motion stage, realize the high-precision and high-resolution linear control; measure the output voltage of the display power amplifier module and The current micro-displacement variation of PZT sensor control, the module can receive and process control commands from the computer through the computer interface, and can also perform functions such as human-computer interaction through the keyboard, LCD, and software. To detect sensor feedback signals in a nanopositioning mechanism such as a PZT or a micro-motion stage, connect the supplied connector to the SENSOR MONITOR signal on the front panel of the position sensing module. The other end is connected to the measuring instrument for detection. The connector red fish clip is the positive pole and the black fish clip is the negative pole.

## Annex 3.E00/E01 Series Picture

### E00/E01 modular controller combination example

#### A Series



1×E01 chassis and power supply module  
1×E01 power amplifier module



1×E00 chassis and power supply module  
6×E03 power amplifier module



1×E01 chassis and power supply module  
3×E05 power amplifier module

### B Series



1×E01 chassis and power supply module  
 1×E05 power amplifier module  
 1×E09 PZT Sensor Control Module



1×E00 chassis and power supply module  
 3×E05 power amplifier module  
 3×E09 PZT Sensor Control Module



1×E01 chassis and power supply module  
 1×E03 power amplifier module  
 1×E09 PZT Sensor Control Module

### C Series



1×E01 chassis and power supply module  
 1×E05 power amplifier module  
 1×E18 display and interface module



1×E00 chassis and power supply module  
 3×E03 power amplifier module  
 1×E18 display and interface module



1×E01 chassis and power supply module  
 1×E03 power amplifier module  
 1×E18 display and interface module

### D Series



1×E01 chassis and power supply module  
 1×E05 power amplifier module  
 1×E09 PZT sensor control  
 1×E18 display and interface module



1×E00 chassis and power supply module  
 3×E03 power amplifier module  
 3×E09 PZT sensor control  
 1×E18 display and interface module



1×E01 chassis and power supply module  
 1×E03 power amplifier module  
 1×E09 PZT sensor control  
 1×E18 display and interface module

## Annex 4. Module Description

### 1 E03 HVPZT Power Amplifier Module

Danger! E03 power amplifier module can output high voltages, and touching this high voltage can cause serious or even fatal injuries. Only qualified professional technicians can install, operate, maintain and clean the E03 Power Amplifier Module!

#### 1.1 Introduction to the front panel



E03.00 Power Amplifier Module



E03.00S Power Amplifier Module

Identifier	Model	Function
POWER	LED green	The operating status indication of the power amplifier module: Green light on: E03 is operating normally; Green light off: E00/E01 system is off
OVER	LED red	The power amplifier module works abnormally. Red light on: the power amplifier module is in an overcurrent state; Red light off: The power amplifier module is operating properly



Identifier	Model	Function
PZT OUTPUT 	LEMO ERA.00.250. CTL	The output voltage drives the piezoceramic actuator. For E03.00S, the third channel way is constant voltage
CONTROL INPUT	BNC	Control signal input, connecting with external signal (Signal generator, analog signal power, DA card, etc.)
DC-OFFSET	Potentiometer - 10 turns	Manually adjust the input and the signal is superimposed on the "CONTROL INPUT" control signal input.

### 1.2 Load - Voltage - Frequency graph

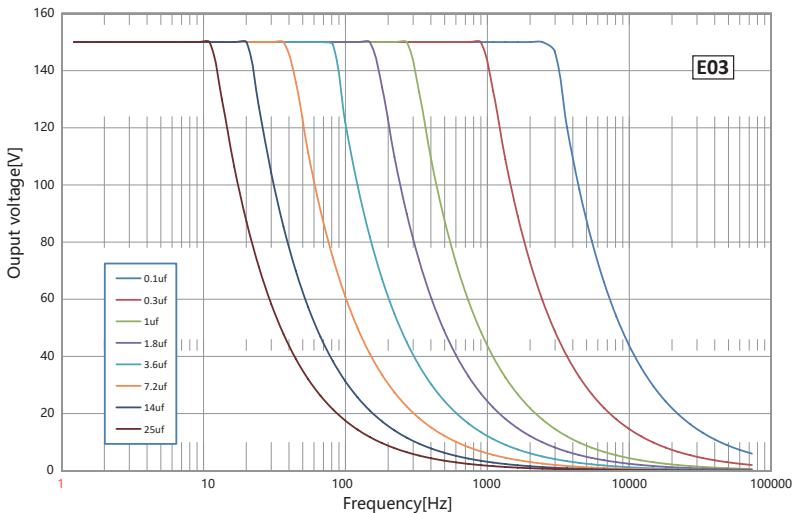

E03 Series Load - Voltage - Frequency Graph

## 2 E05 HVPZT Power Amplifier Module

Danger! E05 power amplifier module can output high voltages, and touching this high voltage can cause serious or even fatal injuries. Only qualified technicians can install, operate, maintain and clean the E05 Power Amplifier Module!

### 2.1 Introduction to the front panel



E05.00 Power Amplifier Module



E05.00S Power Amplifier Module

Identifier	Model	Function
POWER	LED green	The working status indication of the power amplifier module: Green light on: E05 is operating normally; Green light off: E00/E01 system is off
OVER	LED red	The power amplifier module works abnormally. Red light on: the power amplifier module is in an overcurrent state; Red light off: the power amplifier module is working properly
PZT OUTPUT 	LEMO ERA.00.250.CTL	Output voltage driving the piezoceramic actuator. For Model E05.00S, output is constant voltage
CONTROL INPUT	BNC	Control signal input terminal, the terminal and external signal (Signal generator, analog signal power, DA card, etc.) are connected through the supporting input cable.
DC-OFFSET	10-turn potentiometer	The input is manually adjusted and the signal is superimposed on the "CONTORL INPUT" control signal input.

## 2.2 Load - Voltage - Frequency graph

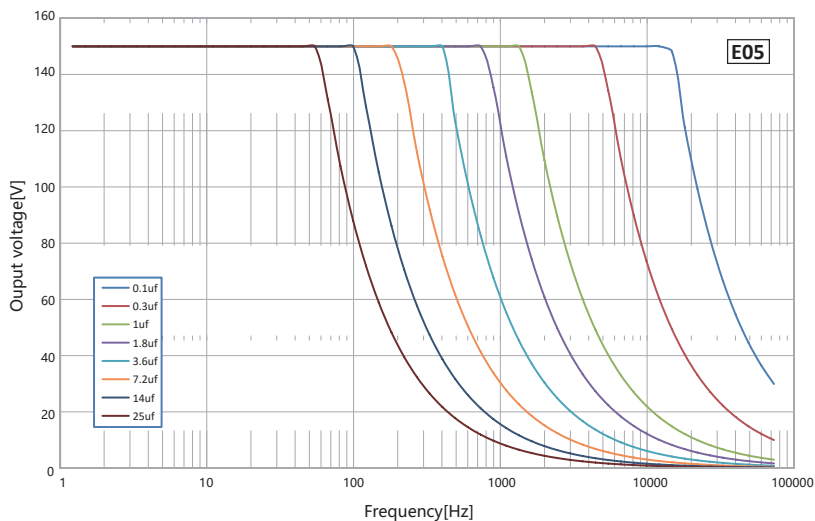

E05.00 Load - Voltage - Frequency Graph

## 3 E06 HVPZT Power Amplifier Module

Danger! E06 power amplifier module can output high voltages, and touching this high voltage can cause serious or even fatal injuries. Only qualified technicians can install, operate, maintain and clean the E06 Power Amplifier Module!

### 3.1 Front panel introduction



E06.00.A2 Power Amplifier Module



E06.00.A4 Power Amplifier Module

Identifier	Model	Function
POWER	LED green	The working status indication of the power amplifier module: Green light on: E06 operating normally; Green light off: E00/E01 system is off
OVER	LED red	The power amplifier module works abnormally. The red light is on: the power amplifier module is in an overcurrent state; Red light off: The power amplifier module operates normally
PZT OUTPUT 	LEMO ERA.00.250.CTL	Output voltage driving the piezoceramic actuator.
CONTROL INPUT	BNC	Control signal input terminal, the terminal and external signal (Signal generator, analog signal power, DA card, etc.) are connected

**NOTE! DANGER!** Directly measure the PZT OUTPUT end or both ends of the accessory cable with an instrument such as an oscilloscope. When the output voltage exceeds 300V, pay attention to the measurement range of the oscilloscope and other instruments, otherwise it will damage your measuring instrument!

### 3.2 Load - Voltage - Frequency graph

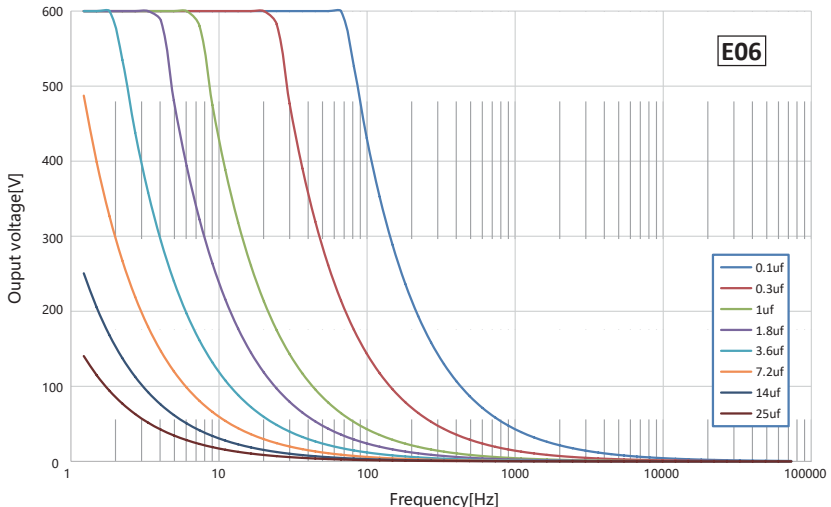

E06.00 Load - Voltage - Frequency Graph

## 4 E07 HVPZT Power Amplifier Module

Danger! E07 power amplifier module can output high voltages, and touching this high voltage can cause serious or even fatal injuries.

Only qualified technicians can install, operate, maintain and clean the E07 Power Amplifier Module!

### 4.1 Introduction to the front panel



E07.00 Power Amplifier Module

Identifier	Model	Function
POWER	LED green	The working status indication of the power amplifier module: Green light on: E07 operating normally; Green light off: E00/E01 system is off
OVER	LED red	The power amplifier module does not have this function
PZT OUTPUT 	LEMO ZRA.0S.116.CLL	Output voltage driving the piezoceramic actuator.
CONTROL INPUT	BNC	Control signal input terminal, the terminal and external signal (Signal generator, analog signal power, DA card, etc.) are connected
DC-OFFSET	10-turn Potentiometer	The input is manually adjusted and the signal is superimposed on the "CONTROL INPUT" control signal input.

**NOTE! DANGER!** Directly measure the PZT OUTPUT end or both ends of the accessory cable with an instrument such as an oscilloscope. When the output voltage exceeds 300V, pay attention to the measurement voltage range of the oscilloscope and other instruments, otherwise it will damage your measuring instrument!

## 4.2 Load - Voltage - Frequency graph

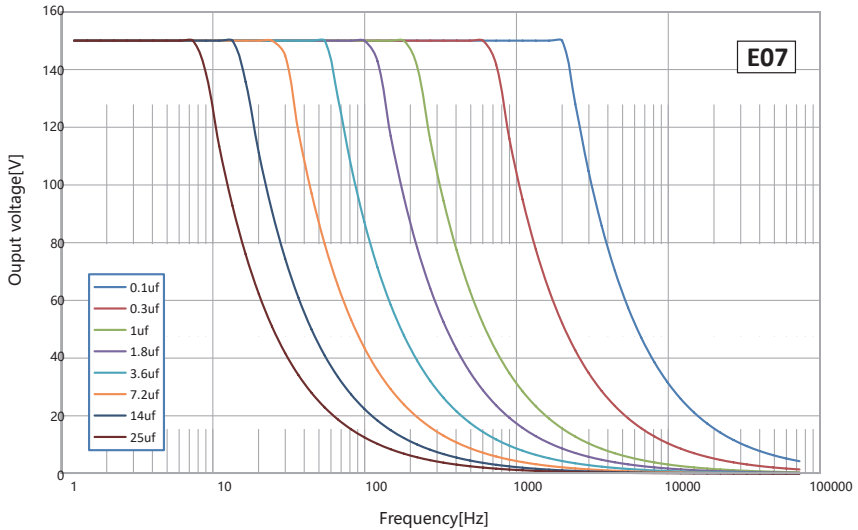

E07 Series Load - Voltage - Frequency Graph

## 5 E Combined Power Amplifier Module

**DANGER!** The combined power amplifier module E07 can output high voltages up to 1800V. The combined power amplifier module E05 can output high voltages up to 800V. Touching this high voltage can cause serious or even fatal injuries. Only qualified technicians can install, operate, maintain and clean the combined power amplifier module!

The combined power amplifier module is based on the principle of high voltage operational amplifier, which realizes power amplification (voltage and current) of the input DC signal or AC signal or random signal, and outputs the amplified signal at the output port to drive the piezoelectric ceramic (PZT). The output of the combined power amplifier module depends on the input signal, and the magnitude and waveform of the output voltage is equal to the input signal multiplied by the amplification factor.

The combined bipolar power amplifier module is a combination of two unipolar high-voltage operational amplifiers. The principle is shown in block diagram. The input voltage value of amplifier CH1 and amplifier CH2 are same, but with opposite polarity of the output voltage. One end of PZT piezoelectric ceramic or capacitive load is connected to the output electrode end of amplifier CH1, and the other end is connected to the output electrode end of amplifier CH2. When input voltage  $U_i$  is positive, the output voltage  $U_{o1}$  of the amplifier CH1 is the amplified positive voltage, and the output voltage  $U_{o2}$  of the amplifier CH2 is the amplified negative voltage.

When the input voltage  $U_i$  is negative, the output voltage  $U_{o1}$  of the amplifier CH1 is the amplified negative voltage, and the output voltage  $U_{o2}$  of the amplifier CH2 is the amplified positive voltage. The output terminals of two independent high-voltage operational amplifiers are connected in series by a PZT/capacitive load. The voltage across the PZT/capacitive load is the sum of the output voltages of the two power amplifier modules. The current at both ends is the current of a single amplifier.

Connect the external signal (signal generator, analog signal power supply, DA card, etc.) to the CONTROL INPUT terminal of the front panel through the matching input cable, and connect the load such as piezoelectric ceramic (PZT) to the PZT OUTPUT terminal of the front panel through the matching output cable. The voltage output at the output end can be controlled by an external signal at the control input. The DC output voltage (offset of the output voltage) can also be adjusted by adjusting the DC-OFFSET knob.

For example: a combined  $\pm 300$  power supply, when the input voltage  $U_i = -5V$ , the output voltage  $U_{o1} = -150V$  of the amplifier CH1, the output voltage  $U_{o2} = +150V$  of the amplifier CH2, voltage difference  $U_{o1} - U_{o2} = -300V$  across PZT/capacitive load. When the input voltage  $U_i = +5V$ , the output voltage of amplifier CH1 is  $U_{o1} = +150V$ , the output voltage of amplifier CH2 is  $U_{o2} = -150V$ , and the voltage difference across PZT/capacitive load  $U_{o1} - U_{o2} = +300V$ . The voltage difference across the PZT/ capacitive load = the voltage difference between pin 1 and pin 2 of the Output end.

5.1 Block diagram of combined bipolar piezoelectric ceramic controller

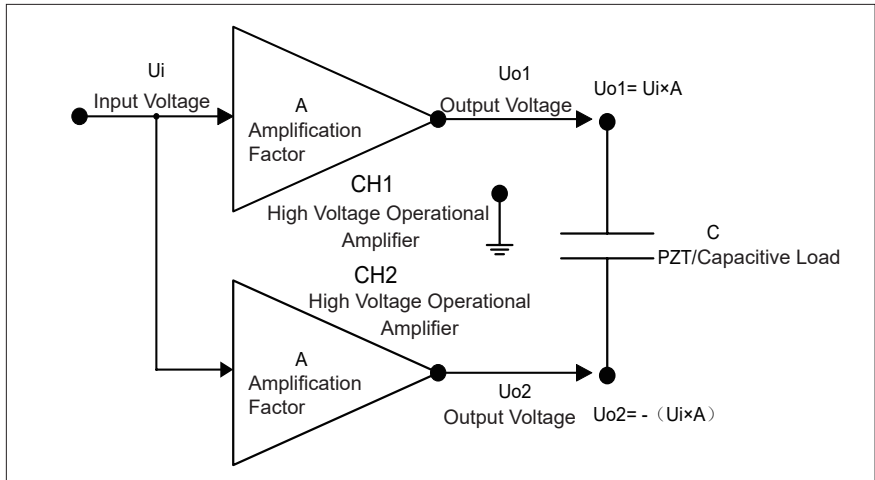

Block diagram of the combined two-electrode piezoelectric ceramic controller

5.2 Front panel introduction



E05.20 Combined bipolar power amplifier module



E07.20 Combined unipolar power amplifier module



Identifier	Model	Function
POWER	LED green	The working status indication of the power amplifier module: Green light on: operating normally; Green light off: E00/E01 system is off
OVER	LED red	The power amplifier module works abnormally. The red light is on: the power amplifier module is in an overcurrent state; Red light off: The power amplifier module is working properly The high-voltage output is short-circuited. When the OUTPUT terminal is short-circuited, the Over indicator is illuminated and the Output is turned off by the internal relay. There is no output at the OUTPUT terminal. Automatic cycle judgment in a cycle of 10 seconds. When the Output is short-circuited, the output is cut off. When the Output terminal is normal, the output is turned on and the loop judgment is stopped. (E07.00 combined bipolar power amplifier module does not have this function)
PZT OUTPUT 	Two-core aerial plug	Output voltage driving the piezoceramic actuator.
CONTROL INPUT	BNC	Control signal input terminal, the terminal and external signal (Signal generator, analog signal power, DA card, etc.) are connected through the supporting input cable. The range of input signals for this terminal is typically in the range of 0 to 10V for unipolar power supplies and -10V to +10V for bipolar power supplies.
DC-OFFSET	10-turn potentiometer	Manually adjust the input, the unipolar power supply is 0 to 10V, and the bipolar power supply is -10V to +10V. This signal is superimposed on the "CONTORL INPUT" control signal input.

### 5.3 Handling precautions

The input ground and output ground of the combined bipolar power amplifier module are connected in common through the front panel, and the front panel is connected to the ground pin of the power line. The analog control cable in CONTROL INPUT terminal is two wires, with the red

clip being the signal input line and the black being the input ground. The matching cable at the output PZT OUTPUT terminal is a three-wire output. Two red clips are two independent single-electrode output lines, and the black clip is a common ground.

When connecting a load such as a piezoceramic (PZT) through a three-wire output cable, carefully determine the polarity of the marking on the matching cable, otherwise the load such as piezoelectric ceramic (PZT) may be damaged.

When one end of a probe of an oscilloscope or similar instrument is connected to the ground, do not directly measure the PZT OUTPUT terminal or the two electrode terminals of the mating cable, otherwise a short circuit will occur.

If a two-phase socket is used to connect the power supply end of the oscilloscope, when the probe of the oscilloscope is separated from the ground, the PZT OUTPUT end or the two electrode ends of the matching cable can be directly measured, but the voltage of the two electrode ends should be less than 300V, otherwise oscilloscope will be damaged.

You can directly measure the PZT OUTPUT terminal or one electrode of the matching cable and ground (Uo1 or Uo2 to the ground) through an instrument such as an oscilloscope. When the output voltage exceeds 300V, pay attention to the measurement voltage range of the test instrument such as an oscilloscope, otherwise the measuring instrument will be damaged.

The multimeter with 1000V range can directly measure the voltage at either end. When the output voltage is greater than 1000V, please use a multimeter with a suitable voltage range to measure the voltage at either end.

When measuring a high voltage with a low-voltage tester, it can be measured by a resistor divider method. It is recommended to connect six 1M $\Omega$ /2W resistors in series that connect with one end of the electrode and the ground or both ends of the electrode, and measure the voltage across one 1 M $\Omega$ /2W resistor.

When measuring the two electrode ends of the PZT OUTPUT terminal, be careful that the instrument probe cannot be connected to the ground.

Before the power is turned off, adjust the DC-OFFSET knob to zero and the input voltage of the CONTROL INPUT terminal is 0V, so that the output voltage of the PZT OUTPUT terminal is 0V, so as to prevent the PZT OUTPUT terminal from having a voltage output when the power is turned on next time, to prevent the human body from getting an electric shock.

### 5.4 Load - Voltage - Frequency graph

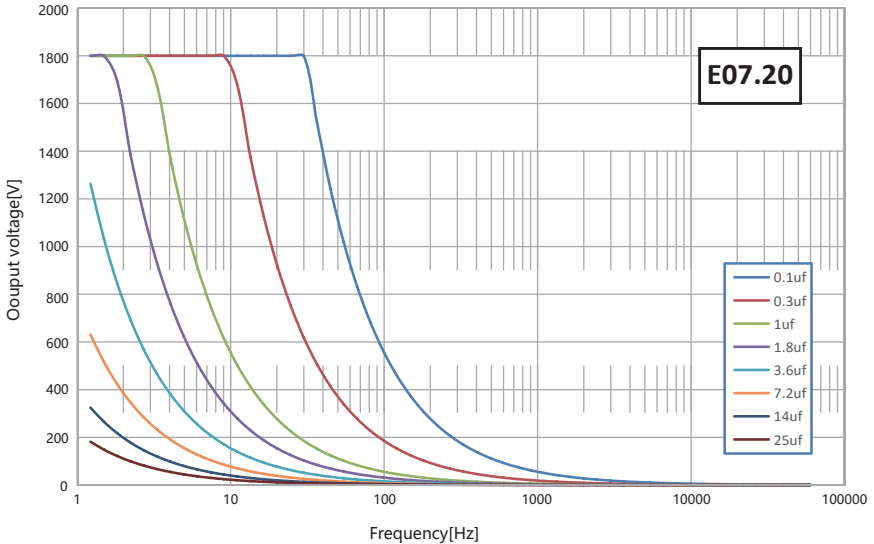

E07.20 Load - Voltage - Frequency Graph

### 5.5 Pin definition

E05.20 shows the combined 800V output connector and E07.20 shows the combined 1800V output connector.

Pin 1	High voltage output electrode of CH1
Pin 2	High voltage output electrode of CH2
Housing	Common ground of CH1 and CH2

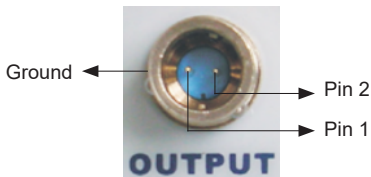

E05.20 bipolar 600V output connector

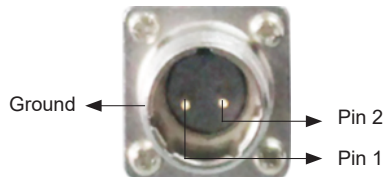

E07.20 bipolar 1800V output connector

Pin electrode output voltage conditions, including 1800V and 600V voltage output parameter table

E07.20 Combined bipolar power amplifier module 1800V			
Channel	CH1 (Pin 1)	CH2 (Pin 2)	CH1 and CH2
Input voltage $U_i$	0 ~ +10V	0 ~ +10V	0 ~ +10V
Nominal output voltage $U_o$	0 ~ +900V	0 ~ -900V	0 ~ +1800V
Knob adjusted output range	0 ~ +900V	0 ~ -900V	0 ~ +1800V

E05.20 Combined bipolar power amplifier module 600V			
Channel	CH1 (Pin 1)	CH2 (Pin 2)	CH1 and CH2
Input voltage $U_i$	0 ~ +10V	0 ~ +10V	0 ~ +10V
Nominal output voltage $U_o$	0 ~ +300V	0 ~ -300V	0 ~ +600V
Knob adjusted output range	0 ~ +300V	0 ~ -300V	0 ~ +600V

## 6 E08 HVPZT Power Amplifier Module

Danger! E08 power amplifier module can output high voltages, and touching this high voltage can cause serious or even fatal injuries.

Only qualified technicians can install, operate, maintain and clean the E08 Power Amplifier Module!

## 6.1 Introduction to the front panel

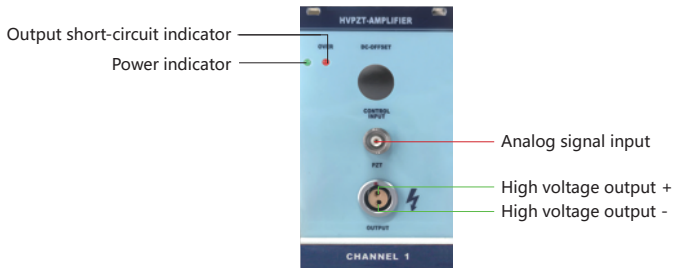

Identifier	Model	Function
POWER	LED green	The working status indication of the power amplifier Module:Green light on: E08 operating normally; Green light off: E00/E01 system is off
OVER	LED red	Output short-circuit indicator
PZT OUTPUT	ZGG.2B.302.CLL	Output voltage driving the piezoceramic actuator.
CONTROL INPUT	BNC	Control signal input terminal, the terminal and external signal (Signal generator, analog signal power, DA card, etc.) are connected
Monitor BNC	BNC	The standard Edition does not have it by default Detects the PZT OUTPUT voltage. It is the same as the input voltage.

Note: Danger! Directly measure the PZT OUTPUT or both ends of the cable through oscilloscope and other instruments. When the output voltage exceeds 300V, pay attention to the voltage range of oscilloscope, otherwise it will damage your measuring instrument!

## 6.2 Load - Voltage - Frequency graph

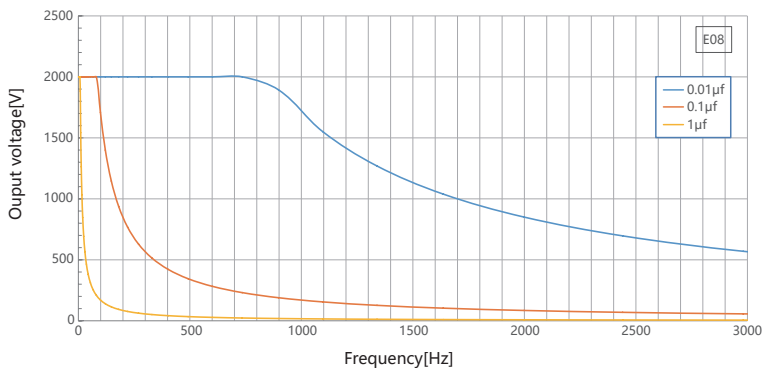

## 7 E09 PZT Sensor Control Module

The E09 series sensor control module can be installed in the E00/E01 system. It provides high-accuracy, high-stability and high-reliability excitation signals for sensors in various nanopositioning mechanisms such as PZT or micro-motion stages, and detects and processes them. Servo control is accomplished by an internal algorithm circuit. It can be applied to resistance strain gauge (SGS) sensors, inductive (LVDT) sensors, and capacitive (CAP) sensors.

Capacitive sensors are one of the best choices if the measurement task requires a very high level of accuracy. The accuracy of the capacitive measurement principle is among the best in many non-contact displacement measurement principles.

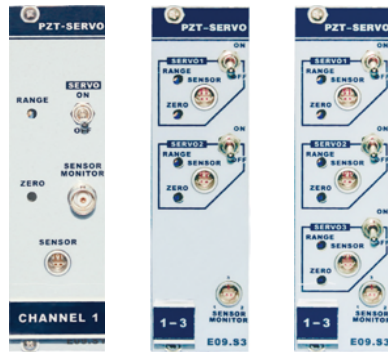

E09.Sx/Lx Piezoelectric Servo Control Module

### 7.1 Introduction to the front panel of SGS sensor and LVDT sensor module

Identifier	Model	Function
RANGE	25-turn Potentiometer	Sensing output (SENSOR MONITOR end) signal amplitude range adjustment hole, generally no adjustment. (calibrated at the factory)
ZERO	25-turn Potentiometer	Sensing output (SENSOR MONITOR end) signal zero offset adjustment hole, generally no adjustment. (calibrated at the factory)
SENSOR	LEMO ERA.0S.304.CLL	The sensor input terminal is used to connect the signal line of the closed-loop piezoelectric ceramic or micro-motion stage sensor (SGS/LVDT).

Identifier	Model	Function
SERVO ON/OFF (1,2,3 is channel number)	Toggle switch	The open loop/servo switch, the OFF position is open loop control mode, and the ON position is servo control mode.
SENSOR MONITOR	E09.S1/L1: BNC	The sensing output signal terminal that can determine the displacement value of the piezoceramic or micro-motion stage by measuring the signal at the end, which is generally an output of 0 to 10V.
	E09.S3/S2/L3/L2: LEMO ERA.0S.303.CLL	

## 7.2 Introduction to the front panel of the capacitive sensor module



E09.C1 Piezoelectric Servo Control Module

Identifier	Model	Function
POWER	LED green	Power on indication
SENSOR	ODU	Sensor input signal of the probe of the capacitive sensor
SENSOR MONITOR	BNC	The sensing output signal terminal that can determine the displacement value of the piezoceramic or micro-motion stage by measuring the signal at the end, which is generally an output of 0 to 10V.

## 7.3 Pin definition

E09.Sx sensor input connector - LEMO ERA.0S.304.CLL

The pin signals are defined as follows:

Pin No.	Cable color	Pin definition
1	Red	+10V
2	White	Sensor feedback signal 1
3	Blue	Sensor feedback signal 2
4	Black	GND
Housing	-	GND(Protect)

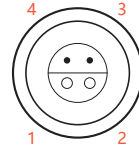

Four-core LEMO sensor input connector

E09.Lx sensor input connector - LEMO ERA.0S.304.CLL

The pin signals are defined as follows:

Pin No.	Cable color	Pin definition
1	Red	Excitation signal source
2	White	Sensor feedback signal 1
3	Blue	Sensor feedback signal 2
4	Black	Excitation signal source
Housing	-	GND(Protect)

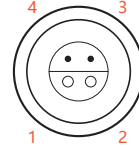

Four-core LEMO sensor input connector

E09.S3/L3 Sensor Output Connector - LEMO ERA.0S.303.CLL

The sensor's output connector has three channels of output signals, and each E09.S3 module comes with an output cable. This cable is the three channels used to test the signal of the sensor monitoring connector. The channel number corresponding to the cable color is as follows:

Pin No.	Cable color	Channel Number
1	Red	CH1
2	White	CH2
3	Red	CH3
Housing	Cable shielding	GND(Protect)

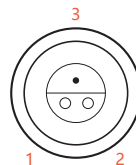

Three-core LEMO sensor input connector



E09.C1 sensing module connector - 32 pin DIN41612 European connector (male)

(1) European connector as shown below:

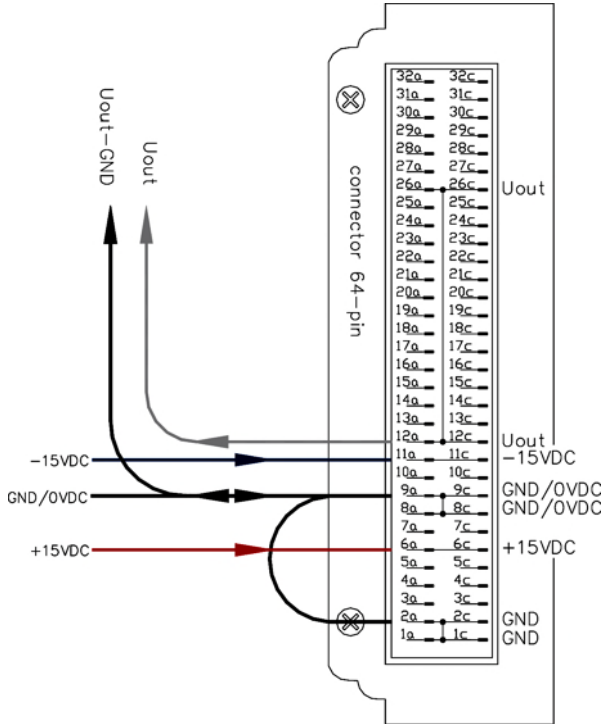

(2) The pins are defined as follows:

Pin Number	Pin Number	Pin Definition
1a	1c	GND
2a	2c	GND
6a	6c	+15VDC
8a	8c	GND
9a	9c	GND
11a	11c	-15VDC
12a	12c	Uout: 0~10V
26a	26c	Uout: 0~10V

Note: The unlabeled pin is empty.

## 7.4 Capacitive sensor image and fixed way

(1) The sensor probe is like a cylindrical structure and is equipped with an integrated wire joint. The capacitive sensor probe is as shown in the following figure:



(2) The cylindrical probe used in the capacitive sensor module can be installed and fixed by a clamp, and the probe can be flush with the fixed surface or partially protruded outward. Only one probe is needed, no other circuit correction measures are required, or an inverting electrode is mounted on the object to be tested, which is more convenient to use. In use, the capacitance of the capacitor is determined by detecting the distance between the probe and the object to be measured, then the sensor output voltage is determined. There are two ways to fix the sensor probe, as shown in the following figure:

1. Use plastic jackscrew to fix

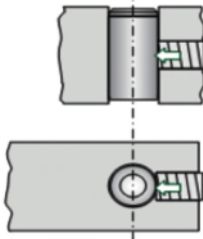

2, use the bayonet to fix (recommended)

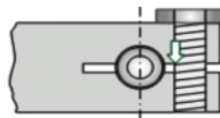

## 7.5 Sensor usage precautions

The capacitive measurement principle requires a clean working environment to avoid changes in the dielectric constant  $\epsilon$  affecting the measurement results!

Capacitive sensor probe installation direction corresponds to the moving surface, the sensor output voltage is positive change!

The probe of the capacitive sensor should be clamped and fixed reliably to avoid the occurrence

of unstable measurement data!

When installing the probe of the capacitive sensor, consider the safe distance from the moving contact surface to prevent damage to the probe due to too close distance!

When applying the board module, the working power supply should be powered by a linear power supply or a switching power supply with extremely low ripple noise!

Do not drag SGS (resistance strain gauge), LVDT (inductive), CAP (capacitive) sensor cables!

Please strictly abide by the signal definition of each sensor, do not arbitrarily change the pin line sequence and cause serious consequences!

## 8 E18 Display and Interface Module

The main control module has one-channel and three-channel versions, with CPU controlling the 24-bit/16-bit DA converter, outputs the analog signal to the power driver module, and measures the output Signal (micro-displacement, measuring the actual variation of nano-positioning mechanisms such as various types of PZT or micro-motion stage) of the position sensing module through the CPU and 16-bit AD converter, display and computer communication.

The LCD display window is a blue screen white character LCD Chinese character display. You can observe the window to understand the working status of the display and interface (serial port, USB) module, and provide a good man-machine interface, which makes the operation easier.

The computer interface includes serial port RS-232 and USB. The serial port baud rate is 9600. The USB interface is a standard 2.0 interface and is compatible with USB1.1. It provides users with standard comment codes and communication protocols for secondary development.

The digital I/O interface can be set to input or output mode, the input mode can control the output and stop of the waveform, and the output mode can track the changes of the controller.

The computer can be connected to the controller module through the corresponding interface and cable. The computer software is powerful and has common waveform output functions such as sine wave, triangle wave, square wave and sawtooth wave.

The 15-bit membrane button input controls the controller's operating mode and operates the controller accordingly.

**For other information, please refer to the following user manual.**

E18 Software Operation User Manual

## 8.1 Front panel introduction



E18 Display and Interface Module

Identifier	Model	Function
DISPLAY	LCD display	<p>The window is a blue-screen white-character liquid crystal Chinese character display. You can observe the window to understand the working status of the display and interface module, and provide a good man-machine interface, which makes the operation easier and easier.</p> <ul style="list-style-type: none"> <li>•For details, please refer to the E18 Software Operation User's Manual.</li> </ul>
RS-232	D-SUB 9-hole socket	<p>The computer is connected to the controller interface module through the RS232 serial port access terminal to realize computer control.</p> <ul style="list-style-type: none"> <li>•For details, please refer to the E18 Software Operation User's Manual.</li> </ul>
	USB-B type connection socket	<p>The computer control is realised by connecting the computer to the controller interface module through the USB port access terminal.</p> <ul style="list-style-type: none"> <li>•For details, please refer to the E18 Software Operation User's Manual.</li> </ul>

Identifier	Model	Function
Digital In/Out	MDR14 connection socket	The interface cable will lead out four pin lines, black for ground and others for 1~3 channel for external logic control and signal acquisition. A program writer interface that can be used for internal retention. <ul style="list-style-type: none"> <li>•For details, refer to the E18 Software Operation User's Manual.</li> </ul>
	Membrane button	The operation mode of the controller and the input of the data amount can be controlled by the membrane button input.

## 8.2 Pin definition

RS-232 interface : D-SUB female

Pin	Signal	Description
2	TxD	RS-232 transceiver
3	RxD	RS-232 receiver
5	GND	RS-232 ground

USB interface : Type B socket





Pin	Signal	Description
1	VCC	Operating voltage +5V
2	D+	Date+
3	D-	Date-
4	GND	Operating voltage ground

Digital In/Out interface : MDR14- female

Pin	Signal	Description
2	I/O	I/O signal of CH1
3	I/O	I/O signal of CH2
5	I/O	I/O signal of CH3
6	GND	Operating voltage ground
7	GND	Operating voltage ground

Prompt! The unlabeled pins in the above connectors are empty signals.

**Annex 5. System accessories**

			
Name	Analog input cable	PZT output coaxial cable	600V PZT output cable
Applicable module	E03/E05/E06/E07	E03/E05/E06/E07	E05.20
Panel interface	CONTROL INPUT	PZT OUTPUT	PZT OUTPUT
Connector	BNC/Alligator clip	LEMO ERA.00.250.CTL/ Alligator clip	Aviation plug/Alligator clip
			
Name	RS-232 Serial cable	Sensor output cable	1200V PZT output cable
Applicable module	E18	E09	E07.20
Panel interface	RS-232	SENSOR	PZT OUTPUT
Connector	D-SUB	LEMO ERA.0S.303.CTL/ Alligator clip	Aviation plug/Alligator clip
			
Name	USB cable	Digital I/O port cable	Power cable
Applicable module	E18	E18	E00/E01
Panel interface	USB-B	Digital In/ Out	AC 220V
Connector	Type A male to B male	MDR14	-